

1st Floor

Made with MagicPlan



THIS FLOORPLAN IS PROVIDED WITHOUT WARRANTY OF ANY KIND. SENSOPIA DISCLAIMS ANY WARRANTY INCLUDING, WITHOUT LIMITATION, SATISFACTORY QUALITY OR ACCURACY OF DIMENSIONS.



Plan 1

382 sq ft

1 Floor

4 Rooms

1 Bedroom

1 Bathroom

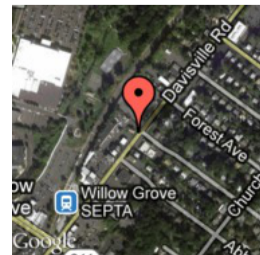

Master Bedroom

Width: 11'2"
Length: 13'1"

Perimeter: 48'8"
Area: 147 sq ft

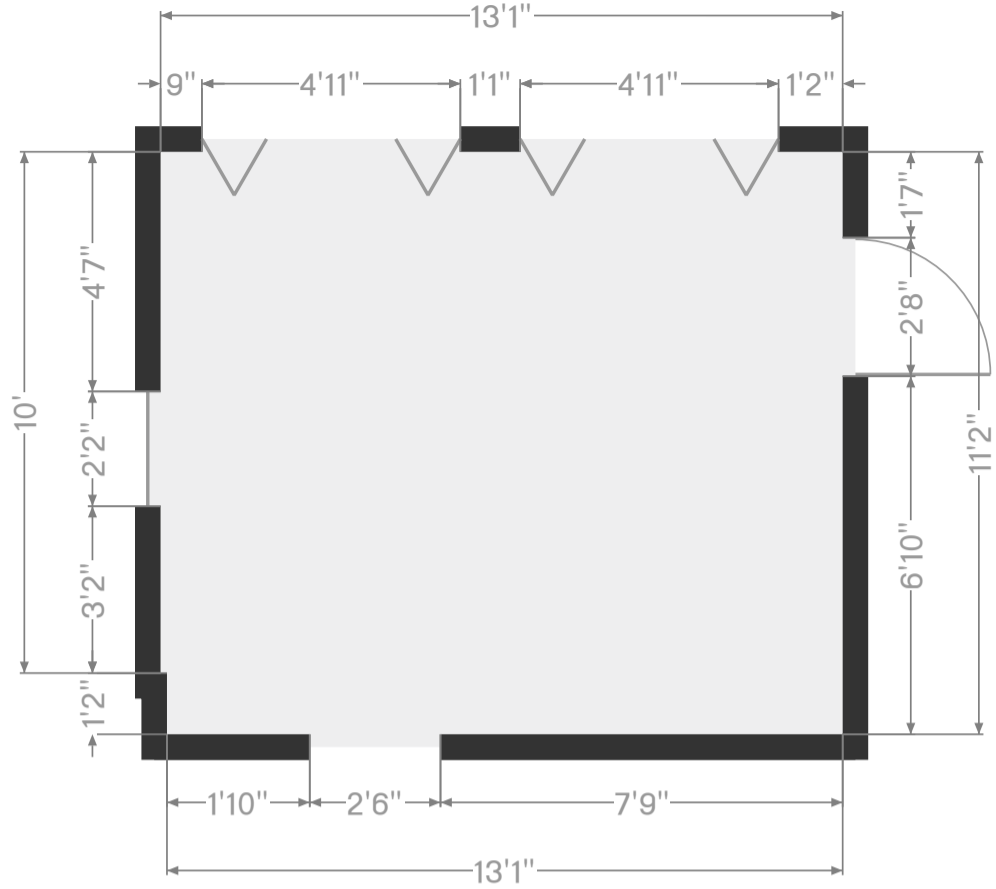
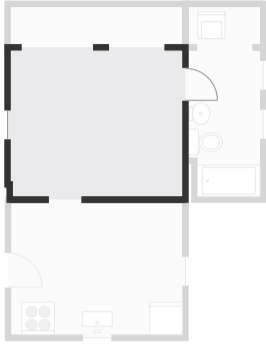

Kitchen

Width: 10'1"
Length: 13'1"

Perimeter: 46'4"
Area: 132 sq ft

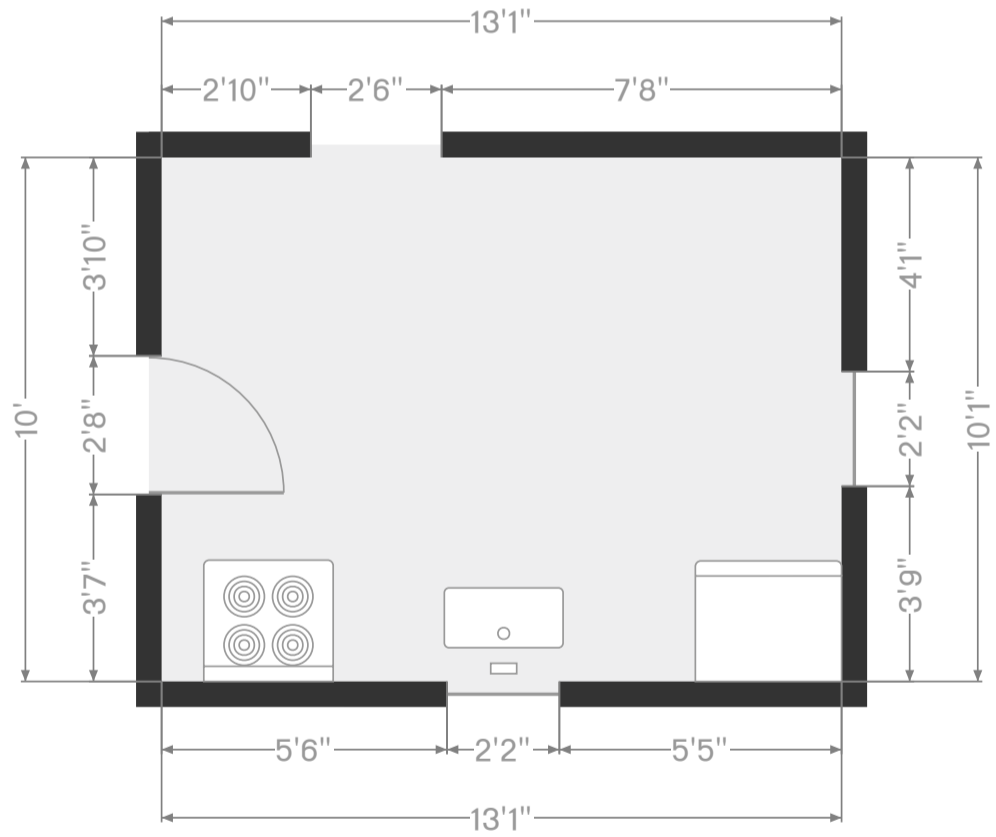
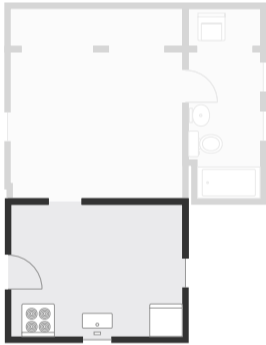

THIS FLOORPLAN IS PROVIDED WITHOUT WARRANTY OF ANY KIND. SENSOPIA DISCLAIMS ANY WARRANTY INCLUDING, WITHOUT LIMITATION, SATISFACTORY QUALITY OR ACCURACY OF DIMENSIONS.

Plan 1



Bathroom

Width: 5'7"
Length: 10'10"

Perimeter: 33'
Area: 59 sq ft

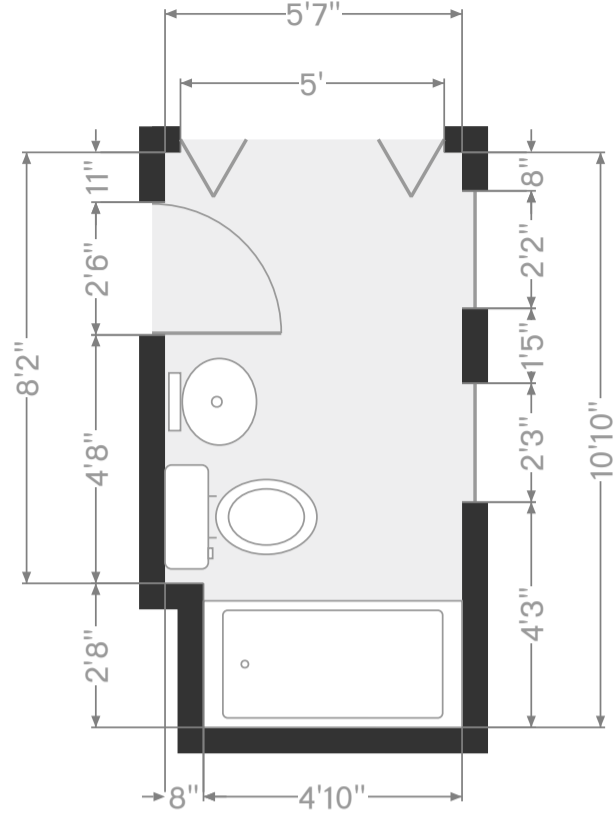
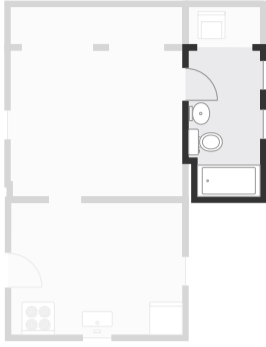

Laundry Room

Width: 2'10"
Length: 5'3"

Perimeter: 16'2"
Area: 15 sq ft

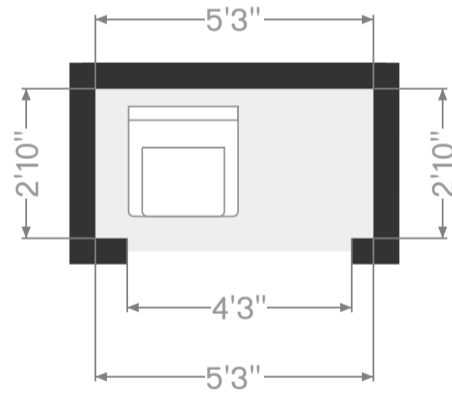

THIS FLOORPLAN IS PROVIDED WITHOUT WARRANTY OF ANY KIND. SENSOPIA DISCLAIMS ANY WARRANTY INCLUDING, WITHOUT LIMITATION, SATISFACTORY QUALITY OR ACCURACY OF DIMENSIONS.

Plan 1

